



t250  
Digital Camcorder

# Quick Start Guide

# 1 Getting Started

All information presented is as accurate as possible but is subject to change without notice. There is no guarantee for the accuracy of the contents in this guide. We reserve the right to change any content or technical rule without prior notification. For more details about the camcorder operation and troubleshooting, please read the User Manual located on the CDROM disc included with your camcorder or visit <http://www.hp.com/support>

## 1.1 Inserting SD Card(s)

1. Open the battery cover.

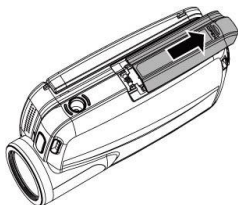

2. Insert the SD card gently into the slot. Make sure the copper contact faces upwards.

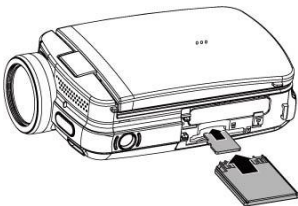

SD card 1:  1 : SD / SDHC card;

SD card 2:  2 : Micro SD card

**Note:** To avoid damage to the camcorder and memory cards, DO NOT insert while powered up. Damage to the memory card will result in loss of video and photos.

## 1.2 Loading the Battery

ONLY use the provided battery or manufacturer recommended battery with this camcorder.

**Note:** Insert the battery correctly according to this description. Failure to do this could result in damage to this camcorder and rare cases result in fire.

1. Open the battery cover.

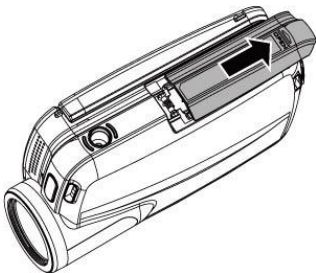



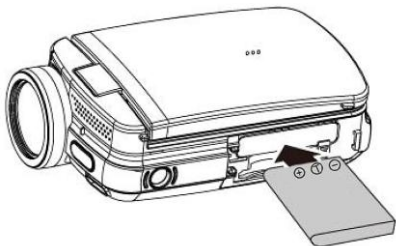

2. Insert the battery according to the illustration. Be sure to have the battery terminal contacts match with the camcorder.

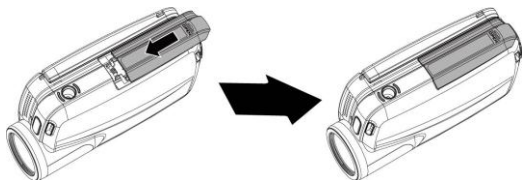

3. Close the battery cover.



### Battery Status Indicator:

	Battery full
	Battery half full
	Battery empty
	<ul style="list-style-type: none"><li>• Charging battery (A new battery should be charged at least 4 hours.)</li><li>• The device power is supplied by DC input. (No battery inside.)</li></ul>

## 1.3 Charging the Battery

Use the AC adaptor to charge the lithium battery, whether the camcorder is on or off. Connect the camcorder to the cable of the AC adaptor. The camcorder battery can be charge by PC or laptop (via USB port) when powered off.

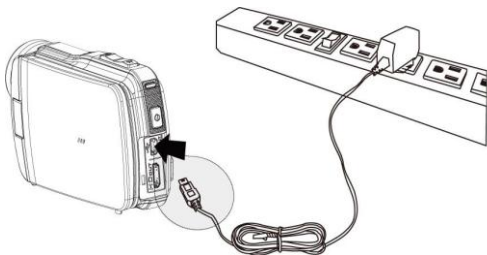



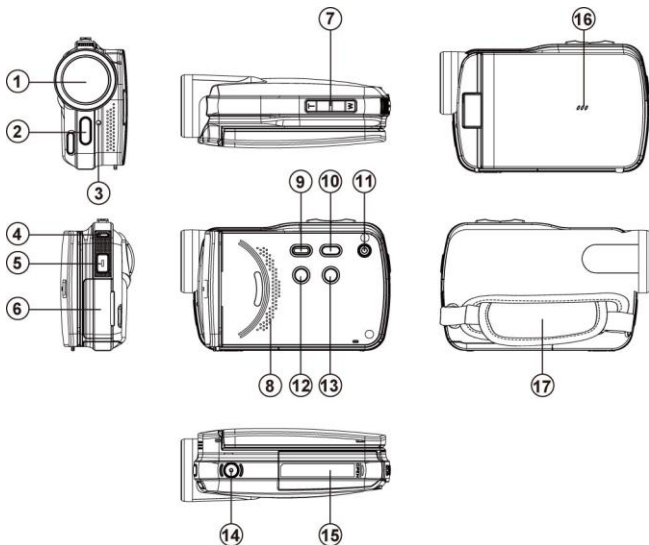



## External View



1	Lens	10	Menu Button
2	LED Light	11	Power
3	Self-timer Indicator	12	Light Button
4	Status Display	13	Mode Button
5	Recording Button	14	Tripod socket
6	USB/HD/TV Output	15	Battery / Memory Card Compartment
7	Zoom Button	16	Microphone
8	Speaker	17	Hand Strap
9	Playback Button		

## 1.4 Buttons & Functions

Description	Button	Function
<b>Power Button</b>		Press the button to turn ON/OFF the power.
<b>Menu Button</b>		Press the button to display the main OSD menu.
<b>LIGHT Button &amp; MODE Button</b>		<ul style="list-style-type: none"> <li>- Press [MODE] to access different the 3 mode of Video, Photo and Voice recording.</li> <li>- Press [LIGHT] to turn ON/OFF the LED light in front of the camcorder.</li> <li>- In MENU and PLAY BACK modes, these buttons can be used for selection of the relevant functions. [LIGHT] is for left and [MODE] is for right.</li> </ul>
<b>Zoom Button</b>		<ul style="list-style-type: none"> <li>- This camcorder is equipped with 5X optical zoom and 4X digital zoom function. Please note that the 4X digital zoom is supported in 720P or lower video resolutions.</li> <li>- The [T] and [W] buttons can be used for function selection in the mode of [MENU]</li> </ul>
<b>Recording Button</b>		Press the start/stop button  to begin / stop video recording, take a photo, or to start/stop voice recording.
<b>Playback Button</b>		Press the Playback button to enter Playback mode and playback the last file.

## 1.5 Initial settings before use

### 1.5.1 Setting Date and Time

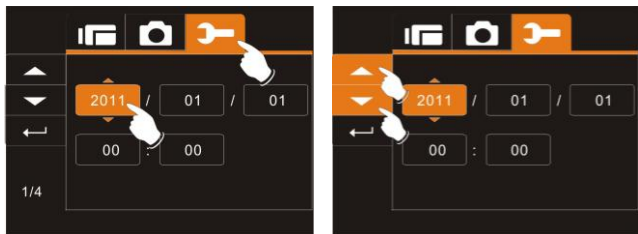

1. Power on the camcorder to set up the date and time for the initial use. Set the date and time by touching the screen to select the field to be modified and touch the up or down arrow icons to change the value as illustrated below.



2. Press Recording Button (  ) to store your changes.
3. Touch the (  ) icon to exit the settings menu.

## 2 Using the Camcorder

### 2.1 Recording a Video Clip

1. Power on the camcorder by opening the LCD panel or pressing the power button. Press the Mode Button (  ) or touch the “DV Mode icon” on the LCD screen to switch to DV mode.
2. Press the Recording Button (  ) to start recording. Press the Recording Button (  ) again to stop recording.
3. The camcorder will store the video clip automatically.

DV Mode Icon





Note: It is recommended to use a 4 GB or greater SD / SDHC memory card for video recording.



## 2.2 Video Clip / Voice Clip Playback

**Note:** Video, Photos and Audios may not play back on the camcorder if:

1. The folder/file name has been changed on your computer.
  2. If the file has been edited / processed on a computer or captured with another camcorder / camera.
1. In DV / Voice Recording Mode, pressing the Playback Button (  ) or touching the Playback Mode icon (  ) on the LCD screen to put the camcorder in playback mode.

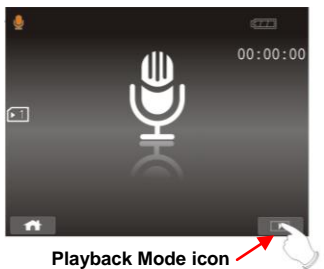
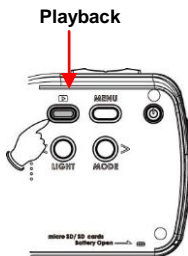



2. Recorded files will appear as thumbnails as illustrated below. Touch the desired mode icon (DV, DSC, or Audio). Touch the thumbnail or use the Zoom Button () to select the file.







2. To Playback or pause the file, press the Recording Button () or touch the screen icons ( / ).



3. Press Playback Button () again or touch the screen to select the Return Button () , the digital video camera will return to recording mode.

4. You can also playback the video clips at different speeds by touching the screen icons (◀◀ and ▶▶). To playback in slower speeds, touch the (⏸<sup>S</sup>) icon to select ON/OFF then touch the (◀◀ and ▶▶) icons to vary the speed. Review the table below for details.





Playback speed is as below when the Slow Motion is “OFF”:			Playback speed is as below when the Slow Motion is “ON”:		
					
Rewind	<b>2X</b> play	Forward	Rewind	<b>1/2X</b> play	Forward
Rewind	<b>4X</b> play	Forward	Rewind	<b>1/4X</b> play	Forward
Rewind	<b>8X</b> play	Forward	Rewind	<b>1/8X</b> play	Forward
Rewind	<b>16X</b> play	Forward	Rewind	<b>1/16X</b> play	Forward

## 2.3 Shooting / Playback Photos

### 2.3.1 Taking a picture

1. Turn on the camcorder. Press the Mode Button (  ) or touch the screen to select the “DSC Mode icon” to switch to DSC Mode.





2. Press the Recording Button (  ) half way to display the auto focus bracket. Wait for the bracket to green which indicates the auto focus is ready and then press the Recording Button (  ) fully to capture the photo. The camcorder will store the picture automatically.

## 2.3.2 Photo Playback



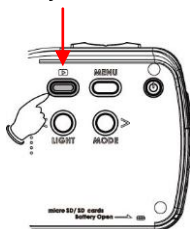

1. In DSC Mode, press Playback Button () or touch the Playback icon to display the images on the LCD screen.

### Playback





2. Touch the file thumbnail or press the Zoom Button () to select the file, and press Recording Button ()





3. Pressing the Zoom Button (  ) or touching the screen to select the Zoom icons (  /  ) will zoom in or zoom out the picture. Press the Mode Button (   ) or touch the screen to select the 4-way icons to move the image.



4. Press Zoom Button (  ) or touch the Return Button (  ) to return to full screen for viewing photos.



5. Press the Playback Button (  ) again or touch the screen to select the Return Button (  ) will restore to DSC capture mode.

## 3 PC and TV Connection

### 3.1 Connecting to the Computer

As shown in the illustration below, use the USB cable provided to connect the camcorder to a PC for file transmission.

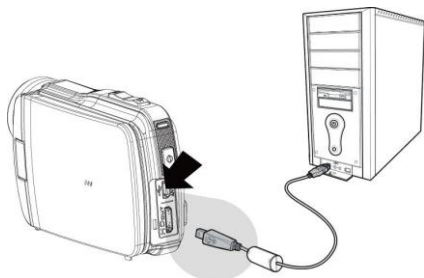

### 3.2 Connecting to a Standard TV

As shown in the illustrations below, either use the provided HDMI cable to connect to a HD TV or the video cable to connect to a standard TV.

HD TV  
Connection

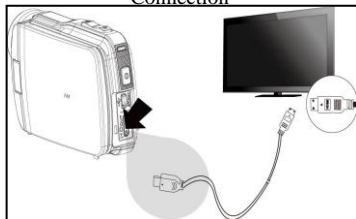

Standard TV  
Connection

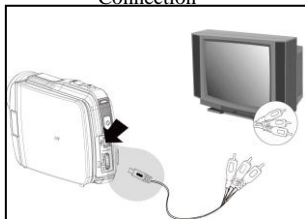

## 4. Troubleshooting

Problem	Possible Cause	Solution
Cannot power on the Camcorder.	<ol style="list-style-type: none"><li>1. Battery is not inserted correctly.</li><li>2. Battery is exhausted.</li></ol>	<ol style="list-style-type: none"><li>1. Please insert battery correctly.</li><li>2. Recharge the Battery.</li></ol>
Camera shutdown suddenly.	<ol style="list-style-type: none"><li>1. Power saving mode already activated.</li><li>2. Battery exhausted.</li></ol>	<ol style="list-style-type: none"><li>1. Please turn on the power again.</li><li>2. Recharge the Battery.</li></ol>
Photos are not stored in the memory.	The camcorder was Powered off before it completed storing the images.	Be sure the Battery is charged and do not power off the camcorder until 5 seconds after a video of photo is recorded.
No sound in PC video playback	Video file is not supported with Windows Media Player	Use Apple QuickTime or ArcSoft TotalMedia Theatre for PC playback.
Camera shutdown when using Self-timer shooting picture.	Battery exhausted	Recharge the Battery.
Images are out of focus	Object exceeds the range of focus or camcorder was not still during recording.	Keep subjects within range and reduce camcorder movement.



<p>Unable to use the external memory card.</p>	<ol style="list-style-type: none"> <li>1. Memory card is Protected.</li> <li>2. Memory card contains non-DCF images taken by other cameras.</li> <li>3. Memory card type or format not supported.</li> </ol>	<ol style="list-style-type: none"> <li>1. Unlock the memory card.</li> <li>2. Reformat the memory card. Please make sure to backup the file before reformatting memory card.</li> <li>3. Use only SD, SDHC or micro SD memory cards.</li> </ol>
<p>All Buttons can not work or camera hangs.</p>	<p>Short circuit occurred when connecting the camera to other device.</p>	<p>Remove the Battery and re-insert after 10 seconds.</p>
<p>Battery power was okay when the camcorder was new, but now lasts only a few minutes.</p>	<p>Rechargeable Batteries do wear out after a year or longer.</p>	<p>Replace the NP-60 battery with same type (mAh rating ` 1050 and 1700).</p>

